

Surface Mount Ultrafast Plastic Rectifier

DO-214AA (SMB)

| PRIMARY CHARACTERISTICS | |
|-------------------------|--------------|
| $I_{F(AV)}$ | 2.0 A |
| V_{RRM} | 300 V, 400 V |
| I_{FSM} | 50 A |
| t_{rr} | 35 ns |
| V_F | 1.1 V |
| $T_J \text{ max.}$ | 150 °C |

FEATURES

- Glass passivated chip junction
- Ideal for automated placement
- Ultrafast reverse recovery time
- Low switching losses, high efficiency
- High forward surge capability
- Meets MSL level 1, per J-STD-020, LF maximum peak of 260 °C
- Solder dip 260 °C, 40 s
- Component in accordance to RoHS 2002/95/EC and WEEE 2002/96/EC

RoHS
COMPLIANT

TYPICAL APPLICATIONS

For use in high frequency rectification and freewheeling application in switching mode converters and inverters for consumer, computer and telecommunication.

MECHANICAL DATA

Case: DO-214AA (SMB)

Epoxy meets UL 94V-0 flammability rating

Terminals: Matte tin plated leads, solderable per J-STD-002 and JESD22-B102

E3 suffix for consumer grade, meets JESD 201 class 1A whisker test, HE3 suffix for high reliability grade (AEC Q101 qualified), meets JESD 201 class 2 whisker test

Polarity: Color band denotes cathode end

| MAXIMUM RATINGS ($T_A = 25\text{ °C}$ unless otherwise noted) | | | | |
|--|----------------|---------------|------|------|
| PARAMETER | SYMBOL | ES2F | ES2G | UNIT |
| Device marking code | | EF | EG | |
| Maximum repetitive peak reverse voltage | V_{RRM} | 300 | 400 | V |
| Working peak reverse voltage | V_{RWM} | 225 | 300 | V |
| Maximum RMS voltage | V_{RMS} | 210 | 280 | V |
| Maximum average forward rectified current at $T_L = 110\text{ °C}$ | $I_{F(AV)}$ | 2.0 | | A |
| Peak forward surge current 8.3 ms single half sine-wave superimposed on rated load | I_{FSM} | 50 | | A |
| Operating junction and storage temperature range | T_J, T_{STG} | - 55 to + 150 | | °C |

| ELECTRICAL CHARACTERISTICS ($T_A = 25\text{ }^\circ\text{C}$ unless otherwise noted) | | | | | | |
|--|--|---|----------|-----------|------|---------------|
| PARAMETER | TEST CONDITIONS | | SYMBOL | ES2F | ES2G | UNIT |
| Maximum instantaneous forward voltage ⁽¹⁾ | 2.0 A | | V_F | 1.1 | | V |
| Maximum reverse current at V_{RRM} | | $T_A = 25\text{ }^\circ\text{C}$ $T_A = 100\text{ }^\circ\text{C}$ | I_R | 10 200 | | μA |
| Maximum reverse recovery time | $I_F = 0.5\text{ A}$, $I_R = 1.0\text{ A}$, $I_{rr} = 0.25\text{ A}$ | | t_{rr} | 35 | | ns |
| Maximum reverse recovery time | $I_F = 1.0\text{ A}$, $dI/dt = 100\text{ A}/\mu\text{s}$, $V_R = 30\text{ V}$, $I_{rr} = 0.1 I_{RM}$ | | t_{rr} | 50 | | ns |
| Maximum reverse recovery current | $I_F = 1.0\text{ A}$, $dI/dt = 100\text{ A}/\mu\text{s}$, $V_R = 30\text{ V}$, $I_{rr} = 0.1 I_{RM}$ | | I_{RM} | 3.0 | | A |
| Maximum stored charge | $I_F = 1.0\text{ A}$, $dI/dt = 100\text{ A}/\mu\text{s}$, $V_R = 30\text{ V}$, $I_{rr} = 0.1 I_{RM}$ | | Q_{rr} | 50 | | nC |
| Typical junction capacitance | 4.0 V, 1 MHz | | C_J | 15 | | pF |

Note:

(1) Pulse test: 300 μs pulse width, 1 % duty cycle

| THERMAL CHARACTERISTICS ($T_A = 25\text{ }^\circ\text{C}$ unless otherwise noted) | | | | |
|---|------------------------------------|----------|------|---------------------------|
| PARAMETER | SYMBOL | ES2F | ES2G | UNIT |
| Maximum thermal resistance ⁽¹⁾ | $R_{\theta JA}$ $R_{\theta JL}$ | 75 25 | | $^\circ\text{C}/\text{W}$ |

Note:

(1) Units mounted on P.C.B. 5.0 x 5.0 mm (0.013 mm thick) land areas

| ORDERING INFORMATION (Example) | | | | |
|---------------------------------------|-----------------|------------------------|---------------|------------------------------------|
| PREFERRED P/N | UNIT WEIGHT (g) | PREFERRED PACKAGE CODE | BASE QUANTITY | DELIVERY MODE |
| ES2G-E3/52T | 0.096 | 52T | 750 | 7" diameter plastic tape and reel |
| ES2G-E3/5BT | 0.096 | 5BT | 3200 | 13" diameter plastic tape and reel |
| ES2GHE3/52T ⁽¹⁾ | 0.096 | 52T | 750 | 7" diameter plastic tape and reel |
| ES2GHE3/5BT ⁽¹⁾ | 0.096 | 5BT | 3200 | 13" diameter plastic tape and reel |

Note:

(1) Automotive grade AEC Q101 qualified

RATINGS AND CHARACTERISTICS CURVES

($T_A = 25\text{ }^\circ\text{C}$ unless otherwise noted)

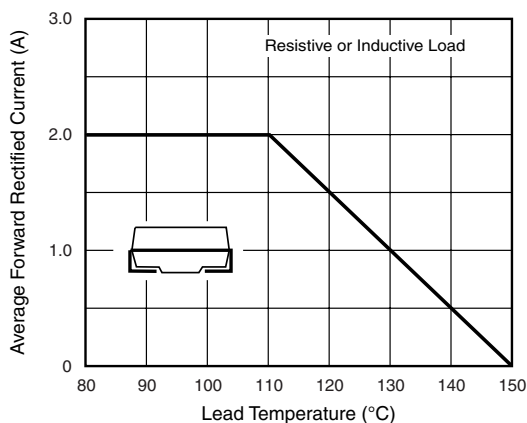

Figure 1. Maximum Forward Current Derating Curve

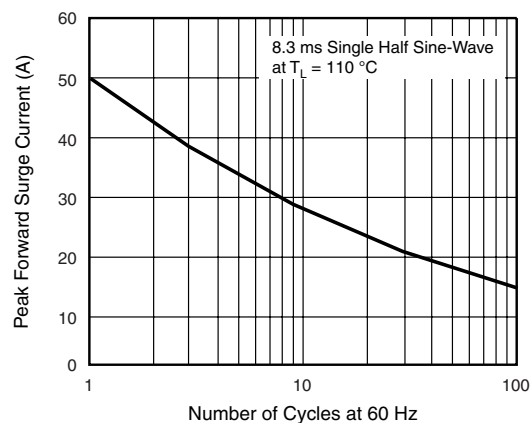

Figure 2. Maximum Non-Repetitive Peak Forward Surge Current

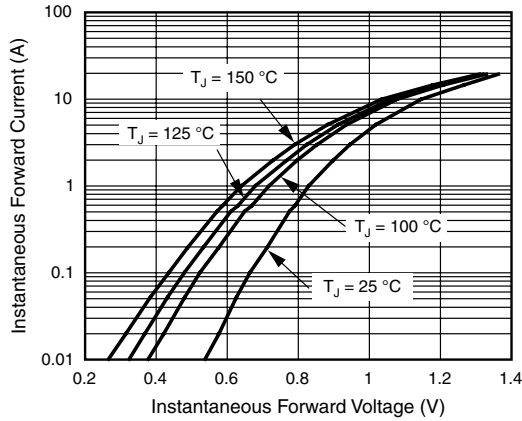

Figure 3. Typical Instantaneous Forward Characteristics

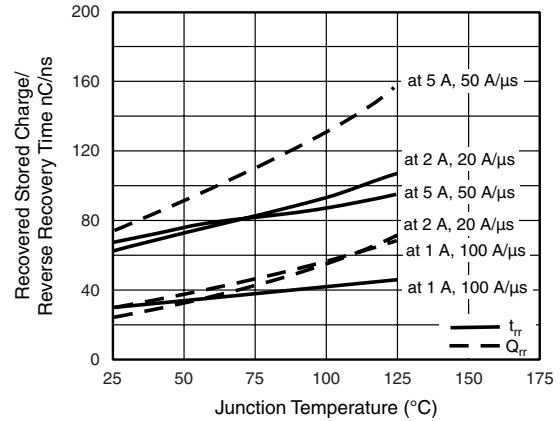

Figure 5. Reverse Switching Characteristics

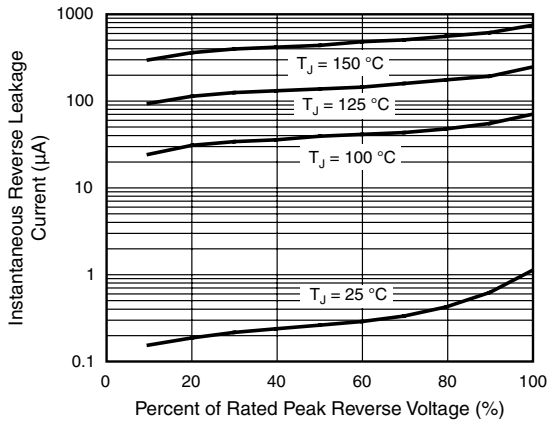

Figure 4. Typical Reverse Leakage Characteristics

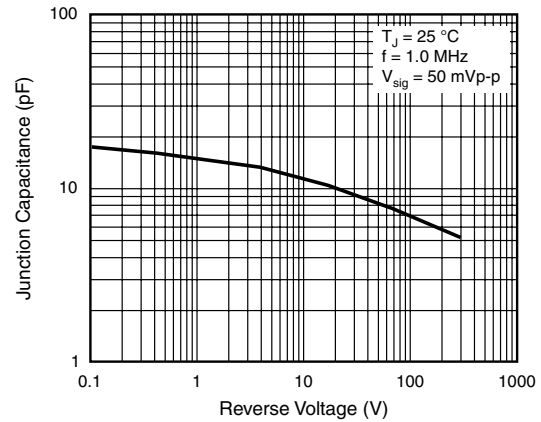
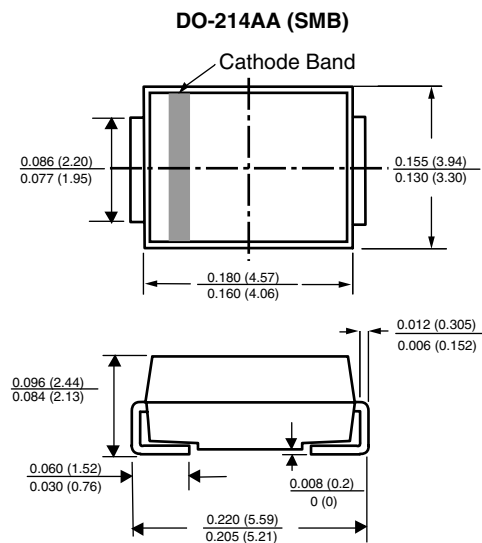
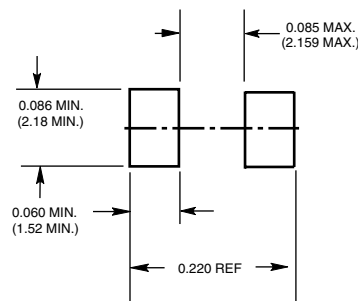

Figure 6. Typical Junction Capacitance

PACKAGE OUTLINE DIMENSIONS in inches (millimeters)



Mounting Pad Layout





Disclaimer

All product specifications and data are subject to change without notice.

Vishay Intertechnology, Inc., its affiliates, agents, and employees, and all persons acting on its or their behalf (collectively, "Vishay"), disclaim any and all liability for any errors, inaccuracies or incompleteness contained herein or in any other disclosure relating to any product.

Vishay disclaims any and all liability arising out of the use or application of any product described herein or of any information provided herein to the maximum extent permitted by law. The product specifications do not expand or otherwise modify Vishay's terms and conditions of purchase, including but not limited to the warranty expressed therein, which apply to these products.

No license, express or implied, by estoppel or otherwise, to any intellectual property rights is granted by this document or by any conduct of Vishay.

The products shown herein are not designed for use in medical, life-saving, or life-sustaining applications unless otherwise expressly indicated. Customers using or selling Vishay products not expressly indicated for use in such applications do so entirely at their own risk and agree to fully indemnify Vishay for any damages arising or resulting from such use or sale. Please contact authorized Vishay personnel to obtain written terms and conditions regarding products designed for such applications.

Product names and markings noted herein may be trademarks of their respective owners.